

CONSTRUCTION GUIDE (FREE EDITION)

TEA HOUSE



Compare our Free vs. Premium plans

() - Partial dimensions in Free Edition*

| Features | Free Edition | Premium Edition |
|-----------------------------------|--------------|-----------------|
| Foundation Plans | ✓ | ✓ |
| Floor Plans | ✓ | ✓ |
| Cross Sections (*) | ✓ | ✓ |
| Elevations (*) | ✓ | ✓ |
| Drain & Water Schema | ✓ | ✓ |
| Electrical Wiring & Installation | ✗ | ✓ |
| Step-by-Step Construction Process | ✗ | ✓ |
| Full Materials & Cutting List | ✗ | ✓ |
| Metal Fasteners & Nails | ✗ | ✓ |
| Tools List | ✗ | ✓ |
| DWG Set of Plans | ✗ | ✓ |
| Technical Support | ✗ | ✓ |
| Plan Modification Services | ✗ | ✓ |

[Click to get the Premium Plan](#)

Layout in imperial measurements

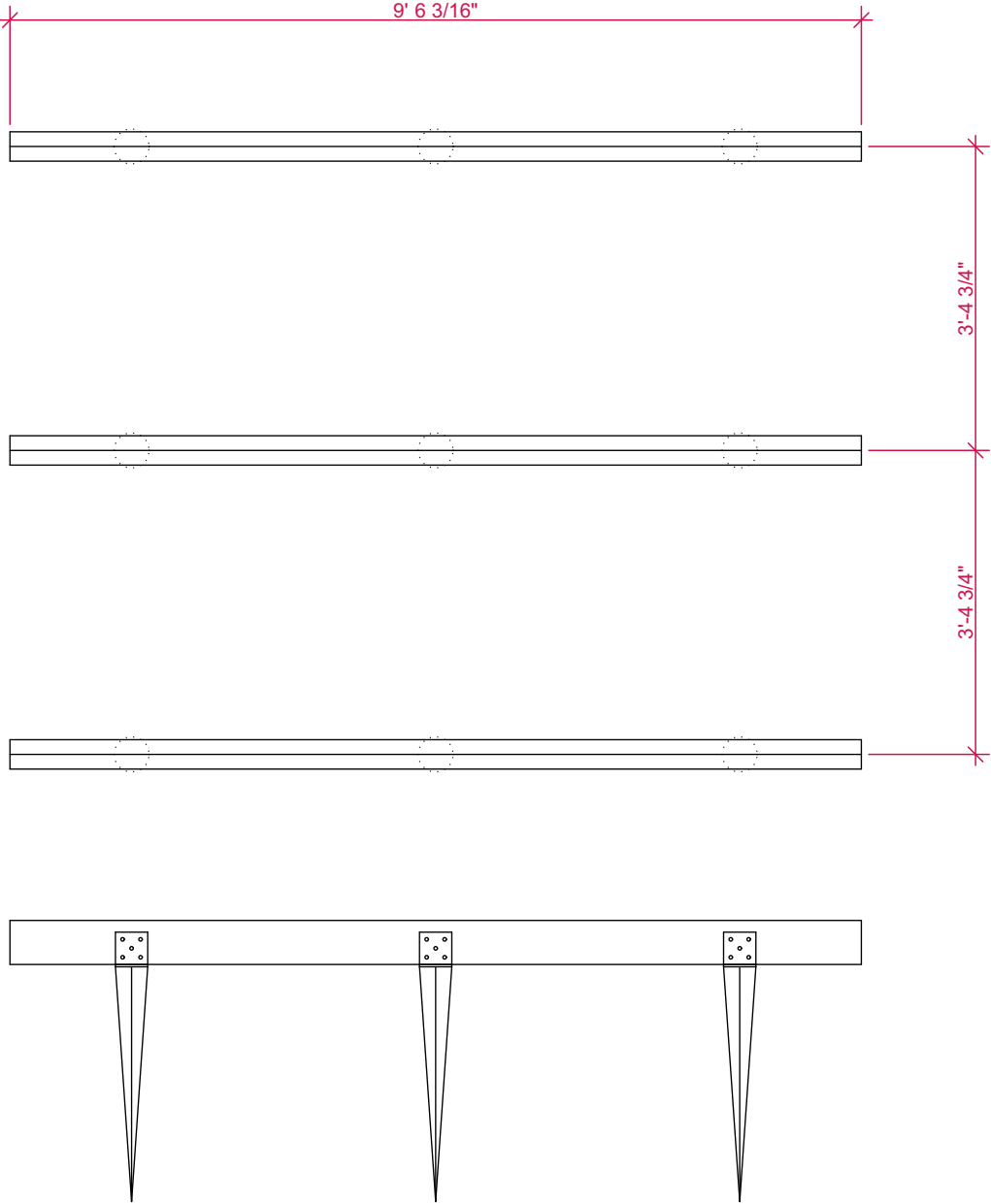

FOUNDATIONS
1:25

TEA HOUSE
Joshua Woodsman
www.pinuphouses.com

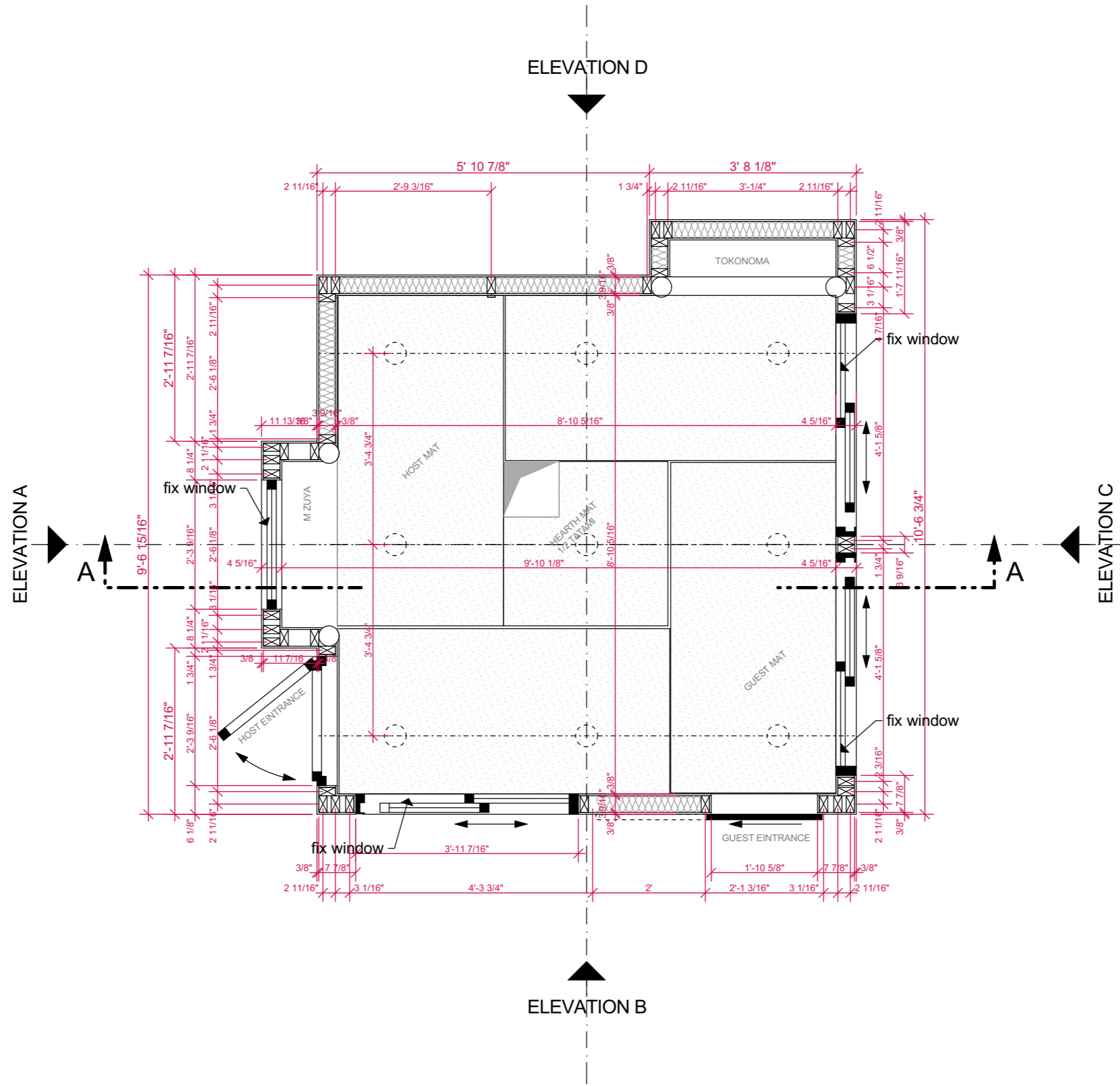

LAYOUT IMPERIAL
1:25

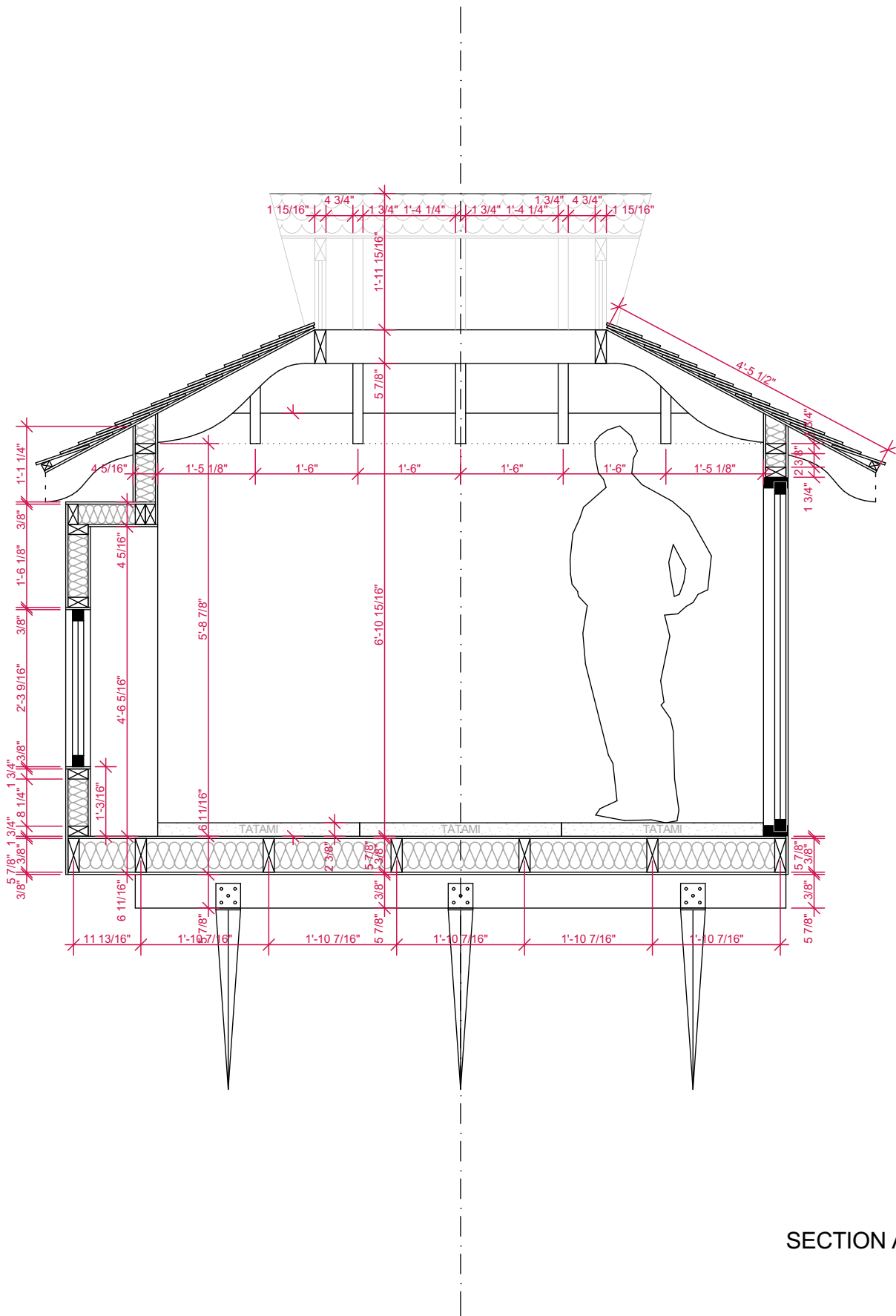

SECTION A IMPERIAL
1:25

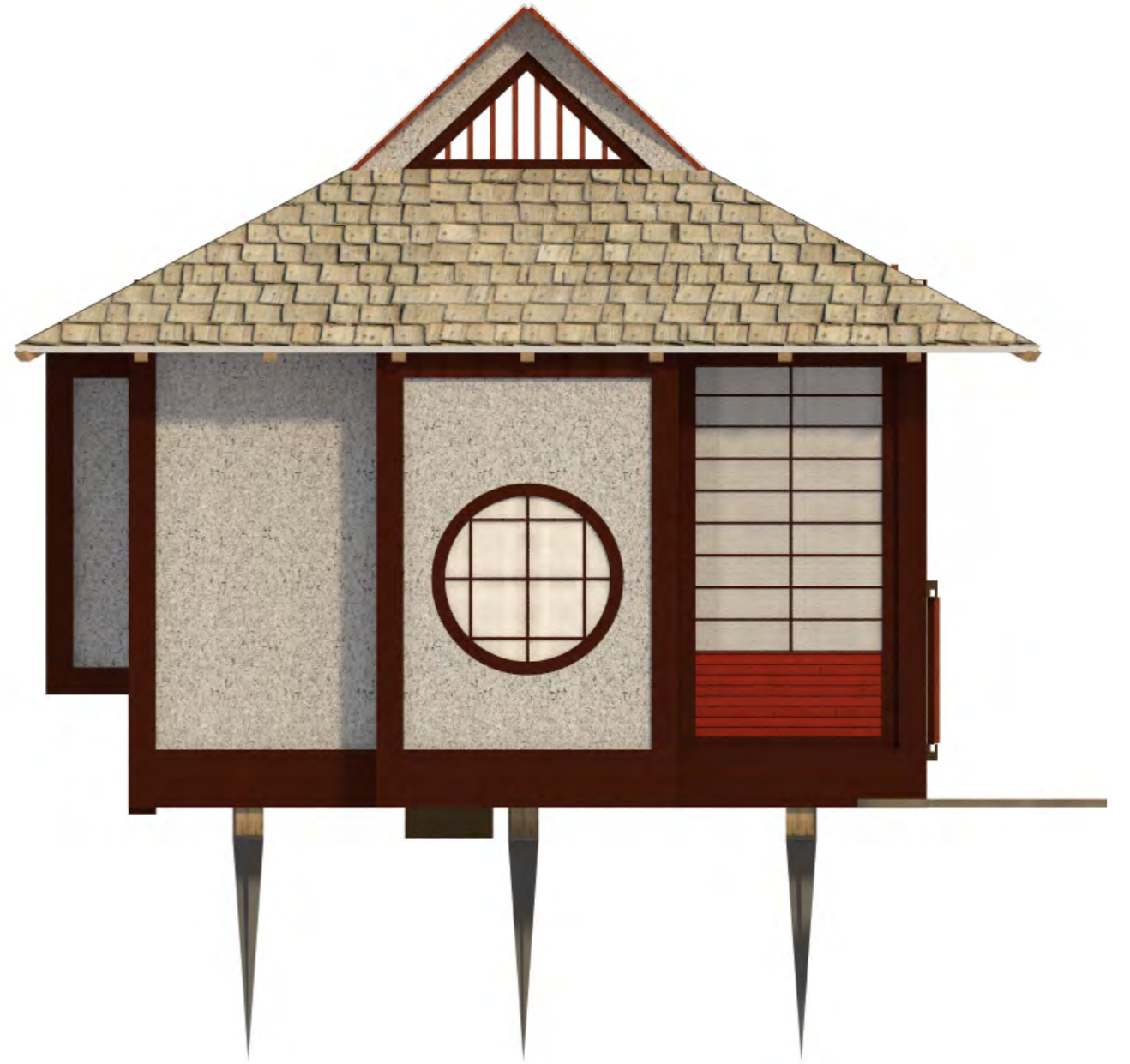
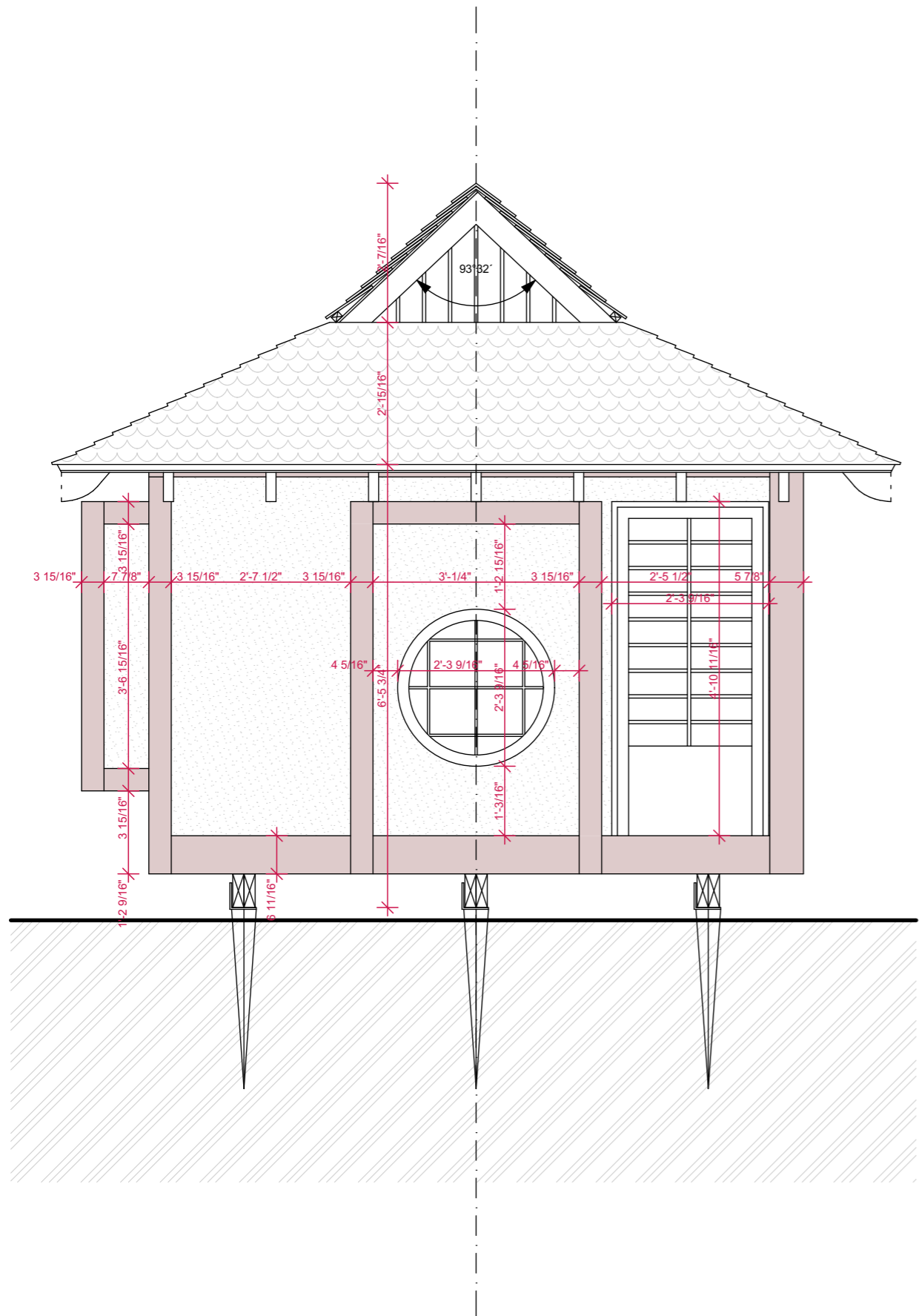

ELEVATION A IMPERIAL
1:25,
1:24,619

TEA HOUSE
Joshua Woodsman
www.pinuphouses.com

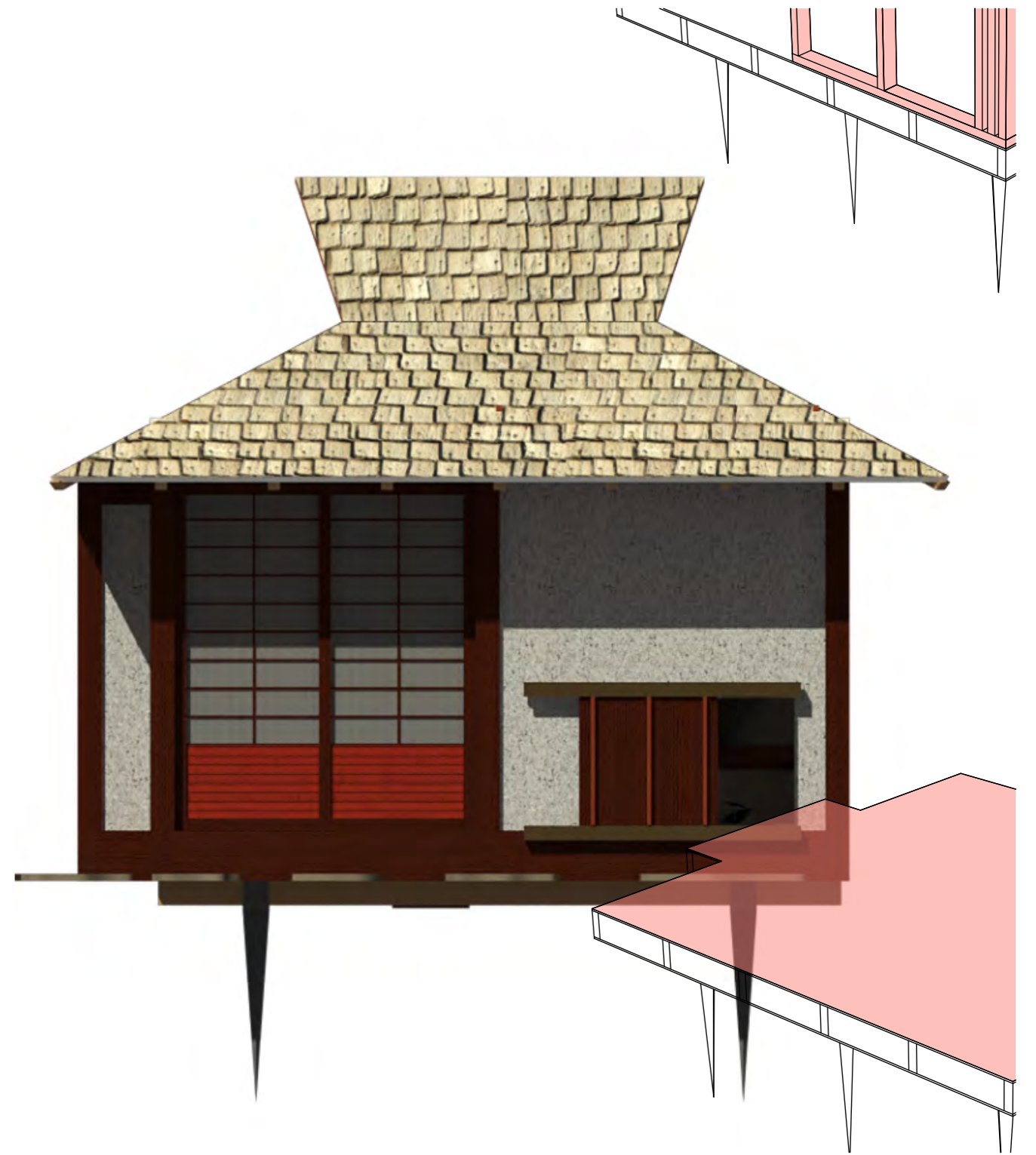
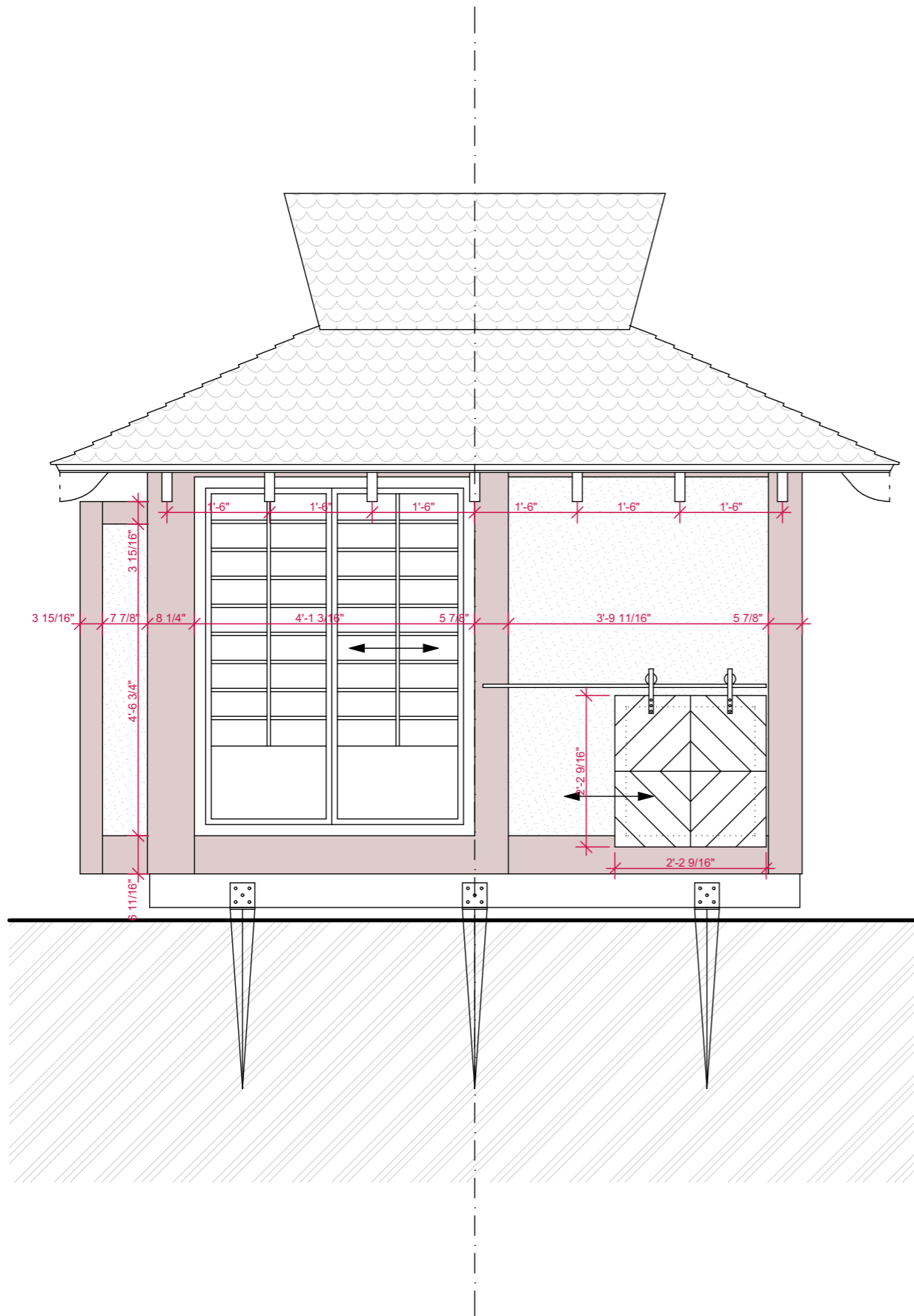

ELEVATION B IMPERIAL
1:25,
1:24,619

TEA HOUSE
 Joshua Woodsman
 www.pinuphouses.com

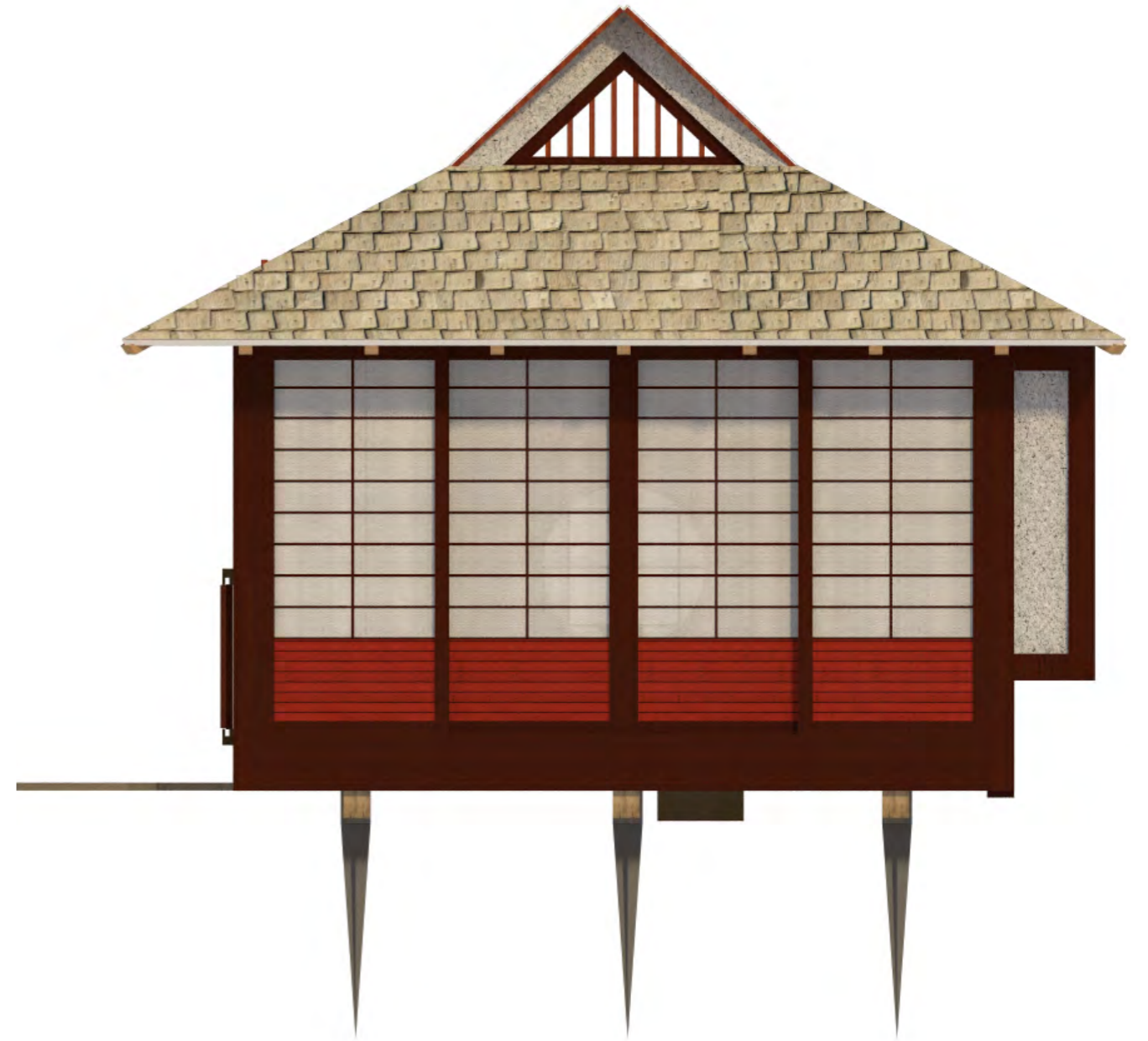
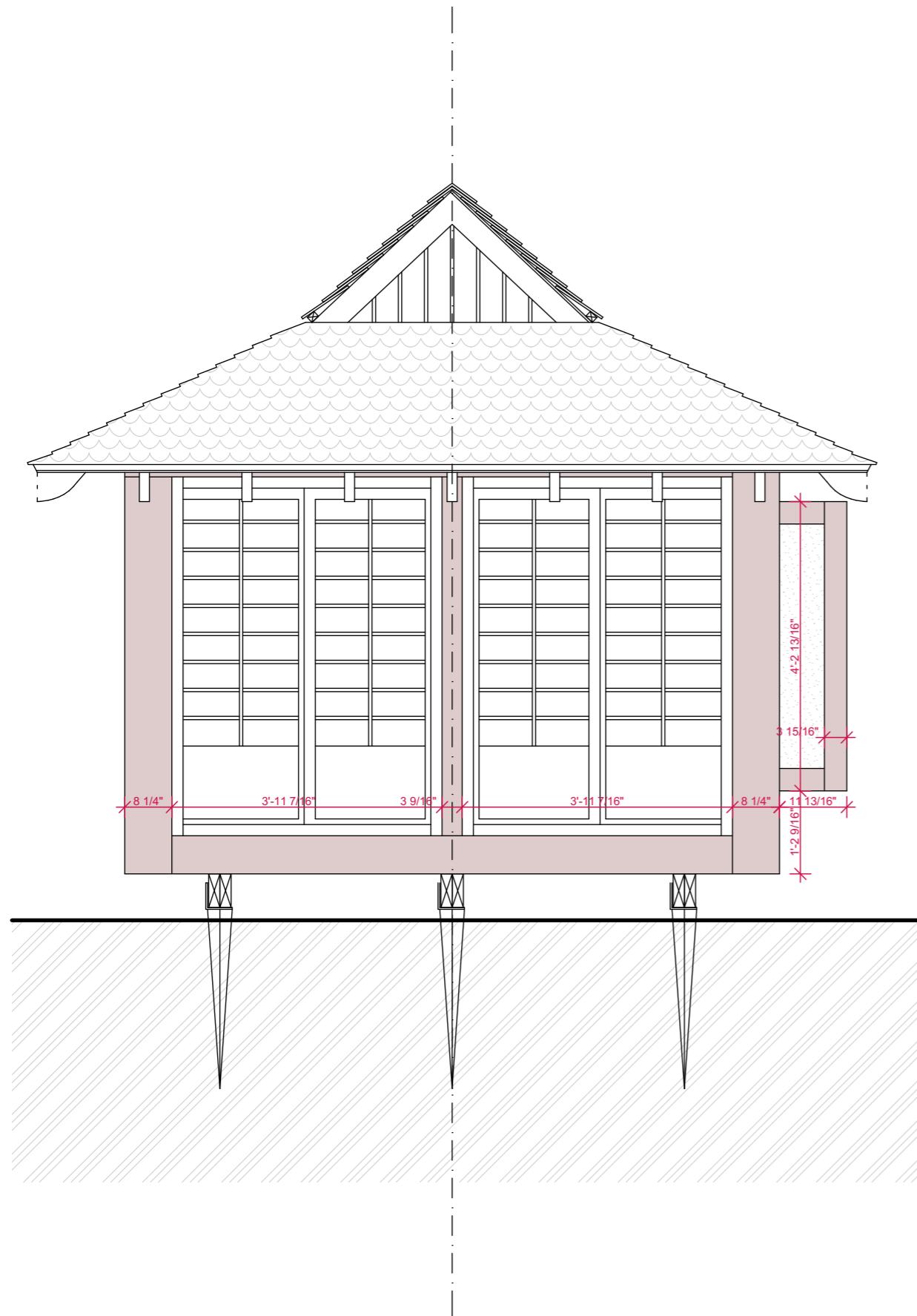

ELEVATION C IMPERIAL
1:25,
1:24,619

TEA HOUSE
Joshua Woodsman
www.pinuphouses.com

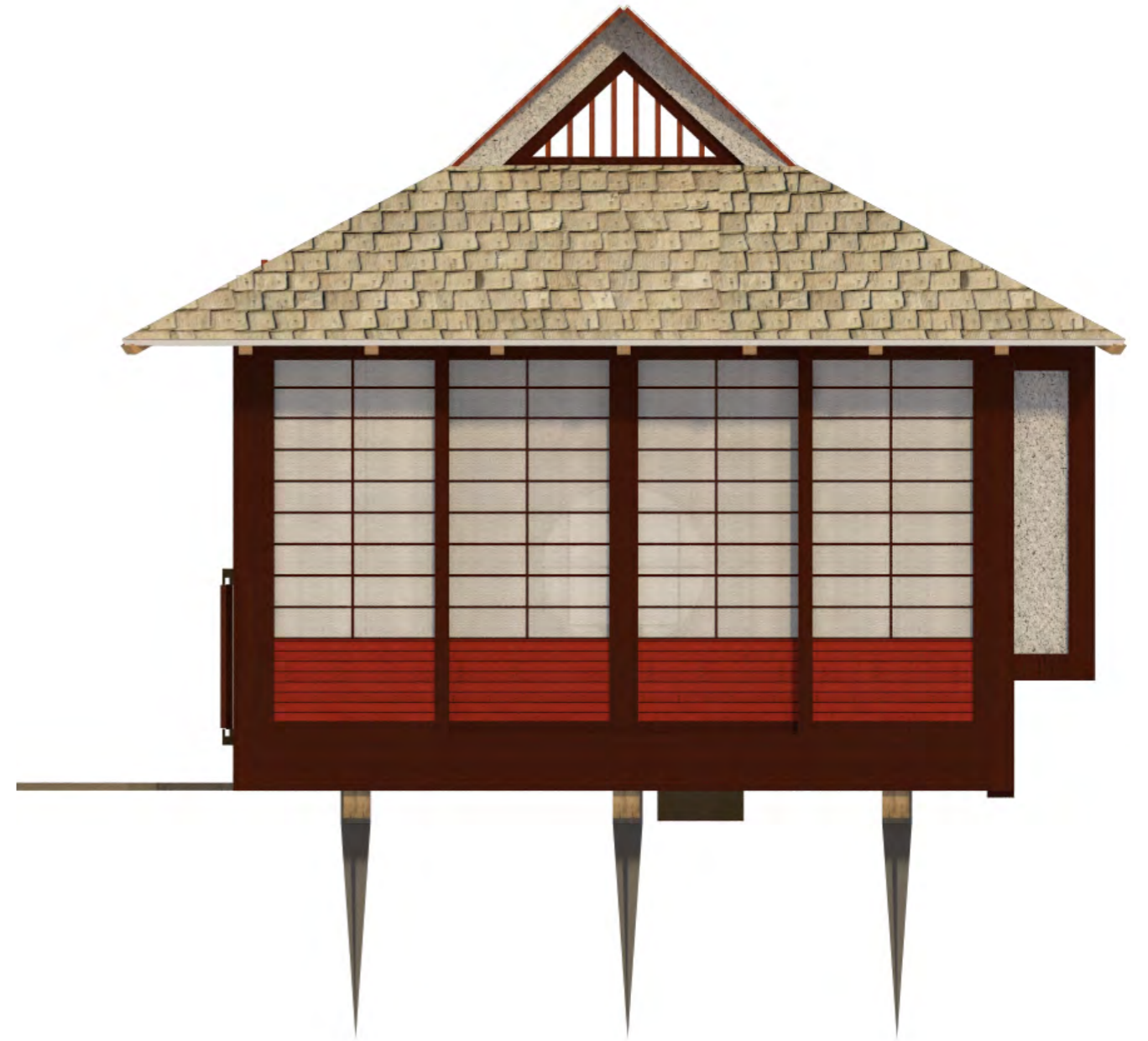
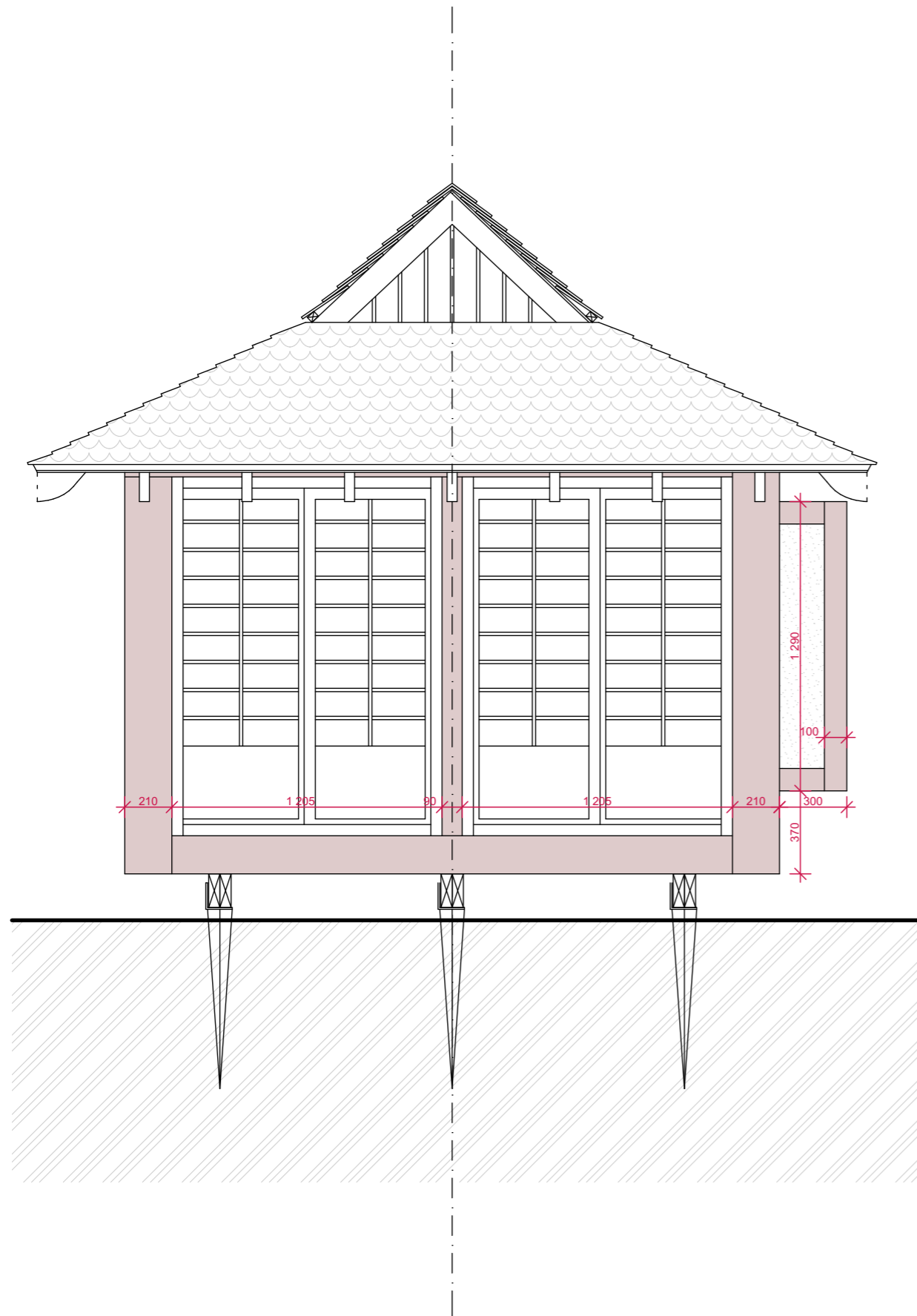

ELEVATION C METRIC
1:25,
1:24,619

TEA HOUSE
Joshua Woodsman
www.pinuphouses.com

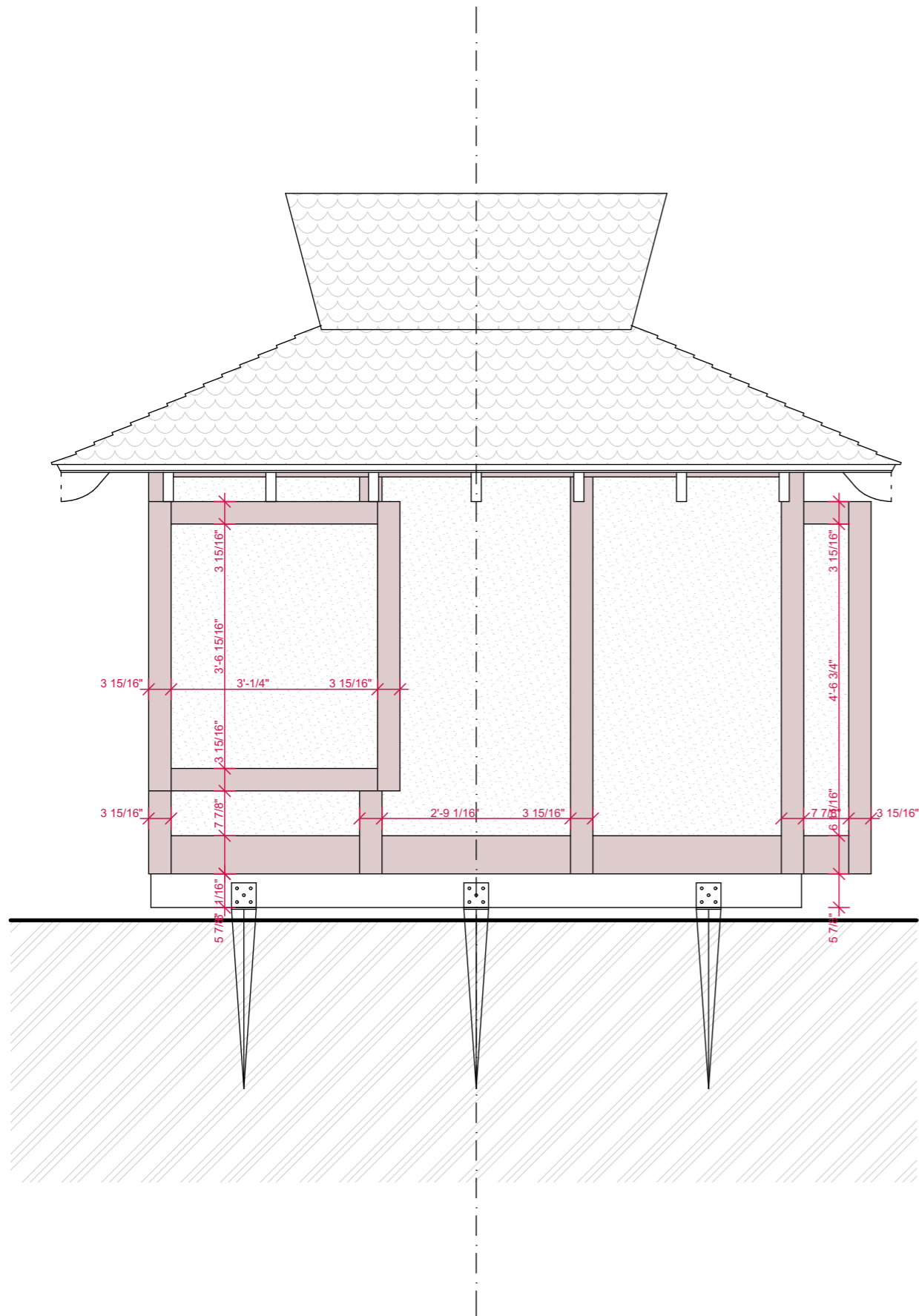

ELEVATION D IMPERIAL
1:25,
1:24,619

TEA HOUSE
 Joshua Woodsman
 www.pinuphouses.com

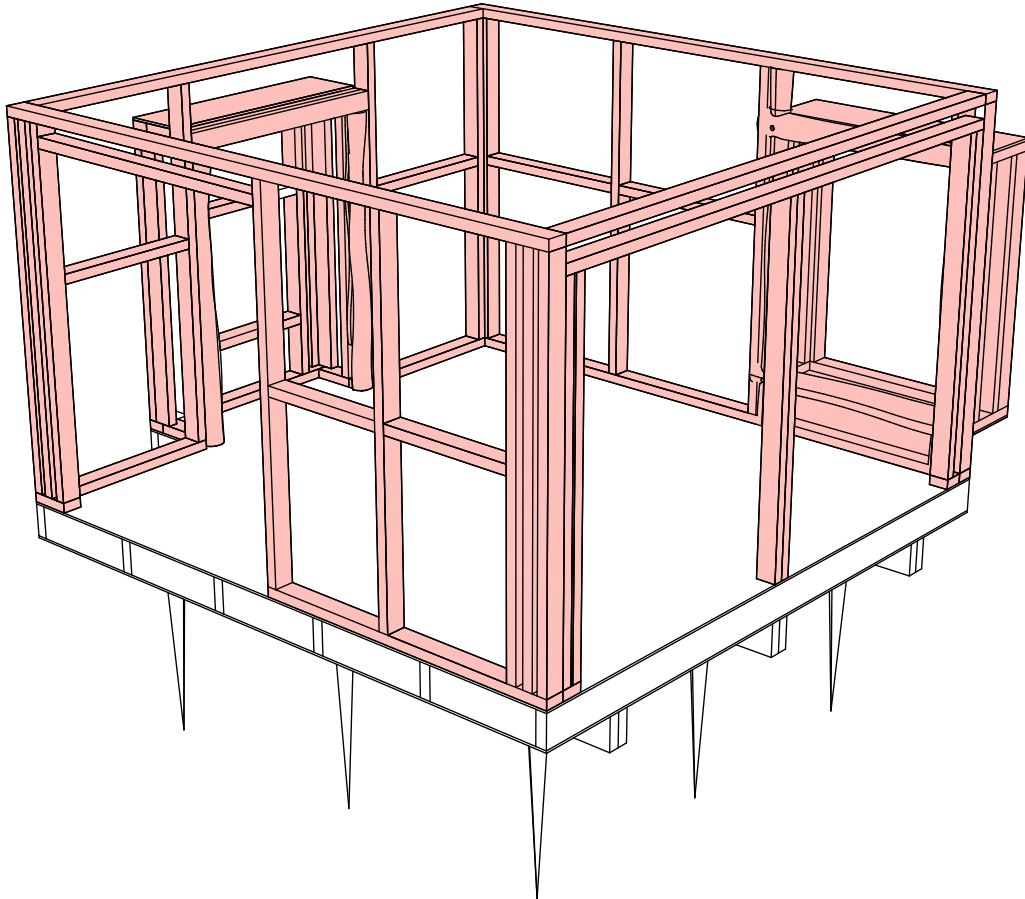

WALL

Assemble the wall on the ground using the level tool. Join to the board and level the structure using the level tool.

STEP-BY-STEP GUIDE SAMPLE PAGE

WALL FRAMING

TEA HOUSE

It is necessary to measure the exact dimensions of all the structural elements directly at the construction site.

Joshua Woodsman
www.pinuphouses.com

Compare our Free vs. Premium plans

() - Partial dimensions in Free Edition*

| Features | Free Edition | Premium Edition |
|-----------------------------------|--------------|-----------------|
| Foundation Plans | ✓ | ✓ |
| Floor Plans | ✓ | ✓ |
| Cross Sections (*) | ✓ | ✓ |
| Elevations (*) | ✓ | ✓ |
| Drain & Water Schema | ✓ | ✓ |
| Electrical Wiring & Installation | ✗ | ✓ |
| Step-by-Step Construction Process | ✗ | ✓ |
| Full Materials & Cutting List | ✗ | ✓ |
| Metal Fasteners & Nails | ✗ | ✓ |
| Tools List | ✗ | ✓ |
| DWG Set of Plans | ✗ | ✓ |
| Technical Support | ✗ | ✓ |
| Plan Modification Services | ✗ | ✓ |

[Click to get the Premium Plan](#)

The Main Advantages of our Affordable Premium Plans

While our free plans can offer a tempting shortcut, they often fall short of providing enough details required for a smooth construction process. This turns out to be especially true if you are not experienced in construction or the DIY field in general. Let's explain how you can benefit by getting the Premium Plan.

Close to 75% of our customers are DIY builders

What does it mean?

In our experience, most of them (up to 90%) contact us for tech support and the rest use our plan modification services. So, by looking at the above stats, we may conclude that even with detailed Premium Plans, most DIY builders contact us for help or order additional services. For experienced DIYers, almost any plan, free or not, may work fine. However, a sizable number of them still buy full sets of plans. **Below are the main reasons.**

1. Save Time & Money with a List of Materials, Cutting, and Tools

With a Full Materials & Cutting List, homeowners and contractors can accurately estimate the quantity and cost of materials needed. Naturally, this may reduce the construction budget and prevent wasting materials.

2. Save Time with Step-by-Step Guidance

A Step-by-Step Construction Process guide is an important part of these plans, offering clear instructions for builders at every stage.

3. Save Time & Materials with Support and Services

Premium Plans come with Technical Support to assist you with any questions or challenges that may arise during construction. Plan Modification Services are often needed to tailor the plans to unique site conditions or specific client requirements.

4. Metal Fasteners & Nails List = Structural Integrity

The inclusion of specifications for correct Metal Fasteners & Nails guarantees that the structural components of your building are securely fastened, adhering to safety standards and enhancing the structure's longevity.

5. DWG Set of Plans for Flexibility and Customization

DWG Set of Plans are provided for those who wish to customize their homes using design software. It allows for easy alterations to the original plan to suit personal tastes or accommodate unexpected changes.

6. No Costly Corrections due to Detailed Design and Precision

Full house plans come with PDF drawings that provide a detailed view of every aspect of the home, from Electrical Wiring & Installation to the placement of each nail.